



Condensing unit
Voltage Code : FZ

CAJN9510ZMHR-FZ

High Temp. Commercial (MHP)

220 - 240V 1~ 50 Hz

R452A / R404A / R448A / R449A

CAJN9510ZMHR-FZ

Conditions	Frequency	Nominal Cooling Capacity		Sound Power ISO3745 / ISO 3743-1
		Watts	BTU/h	
EN13215 / R452A	50 Hz	2201	7505	65 dBA
EN13215 / R404A	50 Hz	2235	7622	65 dBA
EN13215 / R448A	50 Hz	2151	7336	66 dBA
EN13215 / R449A	50 Hz	2152	7340	66 dBA

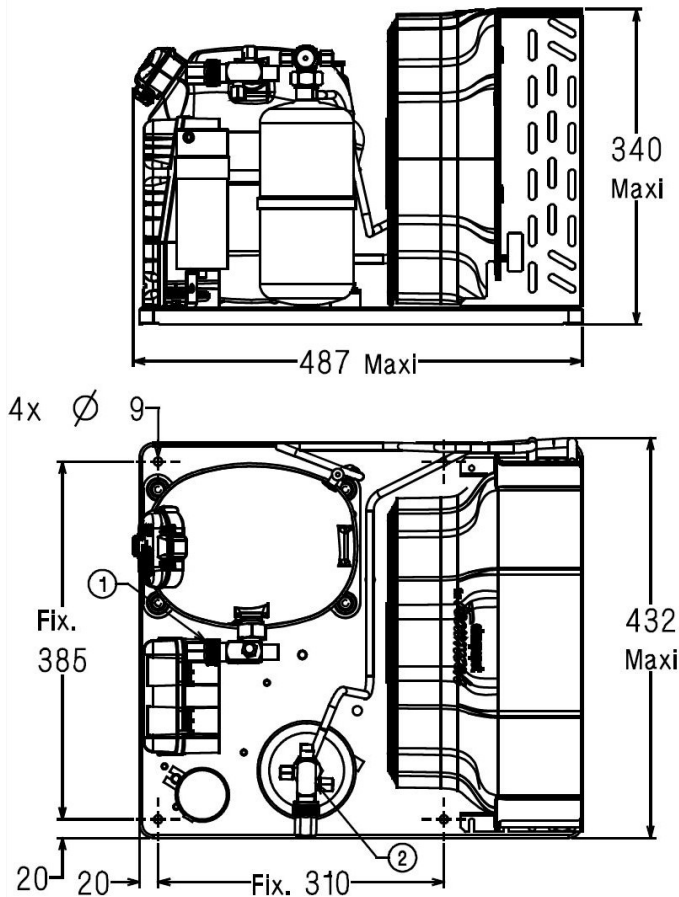

* EN13215 : T°Ambient 32.0°C / T°Evap. 5.0°C / T°Return gas temp.. 20.0°C
T°Subcooling. 3.0K

Net Weight (Kg)	33.0
Expansion device	Expansion_Valve
Air Flow (m³/h)	900
Compo Data Sheet	224ET-FZ
Elec Comp Type	CSR
Current (Amp)	
Load Rated Amp	5.6
Max Cont Current	8.6
Lock Rotor Amp	30
Fan	
Speed (rpm)	1200
Power (W)	30.0
Diameter (mm)	300
Protection	Overload
IP Level	IP54
Condenser	300/3900
Liquid Receiver	
Capacity (L)	1.5
Maximum Pressure (Bars)	32.0
Suction Line	
Suction Type	Vanne Orientable
For Tubing Out Diam	15.9 (5/8")
Suction Connection Type	Brased
Liquid Line	
Liquid Line Type	Vanne Orientable
For Tubing Out Diam	9.5 (3/8")
Liquid Connecton Type	Brased
Connection Type	VR
Fan Guard	maille < à 8mm

Note : Tecumseh reserves the right to change information contained in this document without notification.



Tecumseh

CAJN9510ZMHR-FZ	Tension FZ : 220 - 240V 1~ 50 Hz
------------------------	---

Les performances sont données dans les conditions EN13215 :	Gaz aspirés :	20.0 °C
Condition Dew	Sous refroidissement :	3.0 K
The performance data are in EN13215 conditions :	Return gas :	20.0 °C
Dew Condition	Subcooling :	3.0 K

© 2018 Tecumseh Products Company
All rights reserved

50 Hz R452A

N°6290

5 T ambience	6 T évaporation	(°C)	-25	-20	-15	-10	-5	0	5	10	15
25	1 P frigorifique	(Watt)	830	1046	1288	1554	1843	2150	2471	2802	3140
	2 P absorbée	(W)	590	663	739	820	906	998	1096	1202	1317
	3 I absorbée	(A)	2.92	3.24	3.58	3.94	4.34	4.77	5.23	5.74	6.29
	4 Tc	(°C)	31.5	33.7	36.0	38.4	40.9	43.6	46.3	49.2	52.2
32	1 P frigorifique	(Watt)	723	925	1148	1389	1647	1919	2201	2491	2787
	2 P absorbée	(W)	594	674	758	846	940	1040	1146	1261	1384
	3 I absorbée	(A)	2.91	3.27	3.65	4.05	4.49	4.95	5.46	6.00	6.58
	4 Tc	(°C)	37.4	39.5	41.7	44.0	46.4	48.9	51.5	54.3	57.1
43	1 P frigorifique	(Watt)		731	924	1126	1336	1554	1778		
	2 P absorbée	(W)		682	778	879	986	1100	1220		
	3 I absorbée	(A)		3.28	3.73	4.20	4.70	5.23	5.78		
	4 Tc	(°C)		48.7	50.7	52.8	55.0	57.4	59.8		

50 Hz R404A

N°5049

5 T ambience	6 T évaporation	(°C)	-25	-20	-15	-10	-5	0	5	10	15
25	1 P frigorifique	(Watt)	902	1120	1363	1629	1913	2211	2518	2829	3139
	2 P absorbée	(W)	624	697	775	855	941	1031	1126	1229	1338
	3 I absorbée	(A)	3.09	3.41	3.75	4.11	4.50	4.92	5.38	5.87	6.40
	4 Tc	(°C)	34.3	36.5	38.7	41.1	43.5	46.1	48.7	51.4	54.3
32	1 P frigorifique	(Watt)	789	993	1216	1455	1707	1969	2235	2503	2769
	2 P absorbée	(W)	632	712	796	885	977	1075	1179	1289	1406
	3 I absorbée	(A)	3.09	3.45	3.83	4.23	4.66	5.12	5.61	6.13	6.69
	4 Tc	(°C)	40.1	42.1	44.2	46.5	48.8	51.2	53.7	56.3	58.9
43	1 P frigorifique	(Watt)		790	982	1180	1383	1588	1793		
	2 P absorbée	(W)		727	823	924	1029	1140	1256		
	3 I absorbée	(A)		3.49	3.94	4.41	4.90	5.41	5.96		
	4 Tc	(°C)		51.0	52.9	54.9	57.0	59.2	61.4		

1 = cooling capacity 2 = power input 3 = current 4 = condensing temperature 5 = ambient temperature 6 = evaporating temperature

Nota : Tecumseh se réserve le droit de modifier les informations contenues dans ce document sans préavis.

Note : Tecumseh reserves the right to change information contained in this document without notification.



Tecumseh

CAJN9510ZMHR-FZ	Tension FZ : 220 - 240V 1~ 50 Hz
------------------------	---

Les performances sont données dans les conditions EN13215 :	Gaz aspirés :	20.0 °C
Condition Dew	Sous refroidissement :	3.0 K
The performance data are in EN13215 conditions :	Return gas :	20.0 °C
Dew Condition	Subcooling :	3.0 K

© 2018 Tecumseh Products Company
All rights reserved

50 Hz R448A (*)

N°6980

5 T ambience	6 T évaporation	(°C)	-25	-20	-15	-10	-5	0	5	10	15
25	1 P frigorifique	(Watt)		917	1155	1422	1716	2037	2383	2753	3143
	2 P absorbée	(W)		626	700	780	866	959	1060	1169	1287
	3 I absorbée	(A)		3.06	3.39	3.75	4.15	4.58	5.06	5.58	6.14
	4 Tc	(°C)		34.1	36.4	38.8	41.4	44.0	46.8	49.7	52.7
32	1 P frigorifique	(Watt)			1033	1278	1547	1838	2151	2486	
	2 P absorbée	(W)			719	807	901	1003	1113	1231	
	3 I absorbée	(A)			3.46	3.87	4.31	4.78	5.30	5.85	
	4 Tc	(°C)			42.1	44.4	46.9	49.4	52.0	54.7	
43	1 P frigorifique	(Watt)				1054	1283				
	2 P absorbée	(W)				841	950				
	3 I absorbée	(A)				4.03	4.53				
	4 Tc	(°C)				53.3	55.5				

50 Hz R449A (*)

N°6222

5 T ambience	6 T évaporation	(°C)	-25	-20	-15	-10	-5	0	5	10	15
25	1 P frigorifique	(Watt)		917	1156	1423	1717	2038	2384	2754	3145
	2 P absorbée	(W)		626	700	780	866	959	1060	1169	1287
	3 I absorbée	(A)		3.06	3.39	3.75	4.15	4.58	5.06	5.58	6.14
	4 Tc	(°C)		34.1	36.4	38.8	41.4	44.0	46.8	49.6	52.6
32	1 P frigorifique	(Watt)			1033	1279	1547	1839	2152	2487	
	2 P absorbée	(W)			719	807	901	1003	1113	1231	
	3 I absorbée	(A)			3.46	3.87	4.31	4.78	5.30	5.85	
	4 Tc	(°C)			42.1	44.4	46.8	49.3	51.9	54.7	
43	1 P frigorifique	(Watt)				1054	1284				
	2 P absorbée	(W)				841	950				
	3 I absorbée	(A)				4.03	4.53				
	4 Tc	(°C)				53.3	55.4				

1 = cooling capacity 2 = power input 3 = current 4 = condensing temperature 5 = ambient temperature 6 = evaporating temperature

(*) Veuillez vous référer strictement aux Recommandations d'Utilisation et Bulletins Marketing Tecumseh du fait de la température de reflux élevée pour les applications LBP.

(*) Due to very high discharge temperature especially on LBP conditions, please strictly refer to Tecumseh Guidelines & Marketing Bulletin when using this refrigerant.

Nota : Tecumseh se réserve le droit de modifier les informations contenues dans ce document sans préavis.

Note : Tecumseh reserves the right to change information contained in this document without notification.